



Mfr. Model #: 6266

Part #: TSCW936R

Dimensions: 9" x 36"

Manufacturer: London Mat Industries LTD.

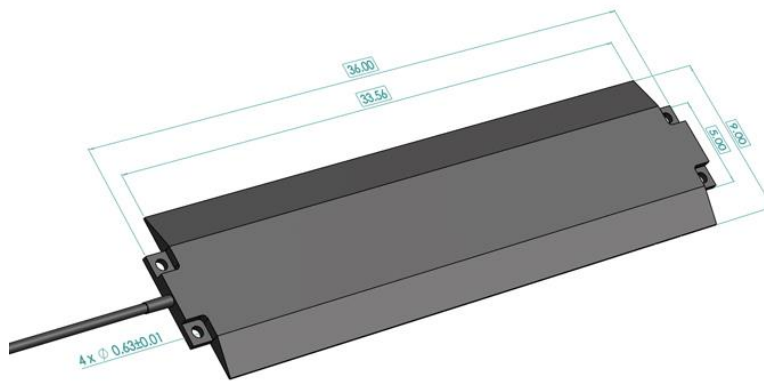

General Specifications

Recommended Voltage & Current	24 VAC or VDC at 1.0 amps maximum
Environment	IP67 rated, 0 to 122°F (-18 to 50°C)
Material	Molded PVC
Lead Wires	18/2 AWG Dri-Run Cable
Colors	Dark Grey
Mounting	3/16 in. (4.8 mm) holes (4) in steel base plate
Weight	19 lbs.
Cable Length	20ft

The Treadle Sensing Mats sense the pressure of a car tire. It is waterproof and can be used in harsh vehicle wash down systems, molded from 100% PVC Plastisol.

Treadle Sensing Mats feature anti-wicking Dri-run cable which provides the lead wires with added protection from moisture.

Features & Benefits

- Heavy duty steel base plate provides solid mounting points
- Dri-Run Cabling prevents moisture wicking through the lead wires
- Completely immersible, IP67 rated mat ensures a long operating life
- Ramped models have ramped edges for easy roll over.